



INSTRUCTION SHEET

BER0009 - 72" RUBBER CUTTING EDGE

INSTALLATION

1. Set the tractor parking brake, stop the engine and remove the ignition key. Place the lift lever in float position and relieve the hydraulic pressure by moving the valve handle back and forth.
2. Remove the blade from the hitch.
3. Turn the blade upside down so the cutting edge is on top. Place a wood block under the blade to avoid damaging the paint.
4. Remove the 5/16" linch pin (item 7) and spacers (item 8) from the skid shoes and take the skid shoes (item 9) off.
5. Remove the original cutting edge by taking off all bolts, lockwashers and nuts, keeping the middle ones for last.
6. Remove only the 5/8" lockwashers and 5/8" NC nuts (items 5-6) from the rubber cutting edge, leaving the carriage 5/8" x 3" bolts there.
7. Align the rubber cutting edge and 5/8" x 3" carriage bolts (items 1-2-3-4) with the holes in the blade. Reinstall 5/8" lockwashers and 5/8" NC nuts (items 5-6) as shown on the figure. Do not tighten.
8. When all the lockwashers and nuts are at their place, you can tighten them.
9. Reinstall the skid shoes (item 9), 5/16" linchpins (item 7) and spacers (item 8).
10. Place the blade back in its original position.
11. Reinstall the blade on the tractor.

IMPORTANT: When installing the rubber cutting edge for the first time: All bolts must be inserted in the middle adjustment of the cutting edge (item 2), as shown on the figure.

Cutting Edge Installation vs. Wear

1. When rubber cutting edge is worn or too close to the blade, flip the cutting edge over (worn side up). Reinstall the bolts in the center holes.
2. When this side is worn, lower the cutting edge and secure in upper holes.

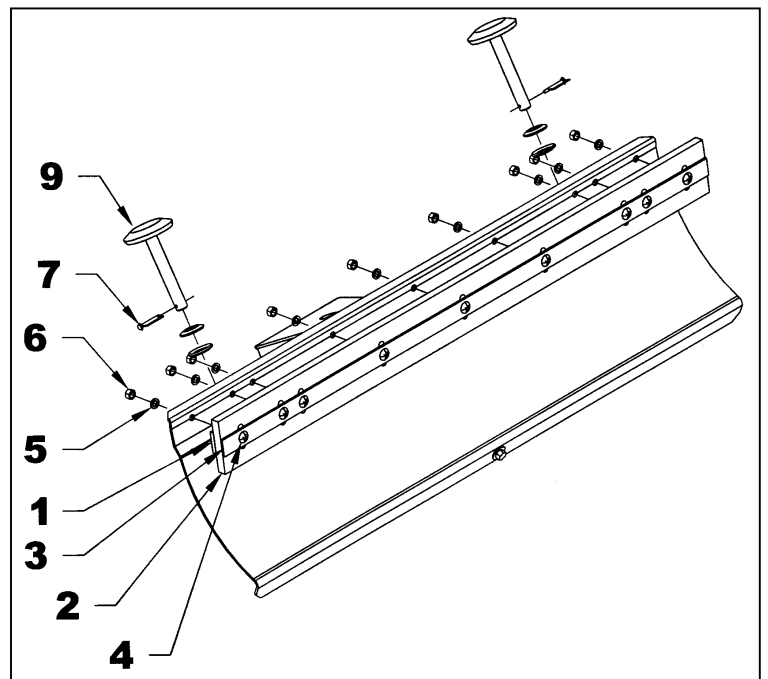



INSTRUCTION SHEET

BER0009 - 72" RUBBER CUTTING EDGE

RUBBER CUTTING EDGE

REF.	DESCRIPTION	QTY	PART #
1	Retaining plate	1	666793
2	Rubber cutting edge	1	666792
3	Flat bar 1/2" x 2 1/2"	1	666794
4	Carriage bolt 5/8" NC x 3" gr.5 PTD	9	O/L
5	Lockwasher 5/8" PTD	9	O/L
6	Nut hex. 5/8" NC PTD	9	O/L

